



5th February, 2002

ADMINISTRATION AND FINANCE COMMITTEE MEETING

NOTICE IS HEREBY GIVEN THAT AN ADMINISTRATION AND FINANCE COMMITTEE MEETING OF THE COUNCIL OF THE CITY OF RANDWICK WILL BE HELD IN THE COUNCIL CHAMBER, TOWN HALL, 90 AVOCA STREET, RANDWICK, ON TUESDAY, 12TH FEBRUARY, 2002 AT 6:00 PM

Committee Members: His Worship, the Mayor, Cr D. Sullivan, Crs Andrews (Deputy Chairperson), Daley, Matson, Matthews, Notley-Smith, Procopiadis (Chairperson) and Tracey.

Quorum: Five (5) members.

NOTE: AT THE EXTRAORDINARY MEETING HELD ON 5TH SEPTEMBER, 2000, THE COUNCIL RESOLVED THAT THE ADMINISTRATION AND FINANCE COMMITTEE BE CONSTITUTED AS A COMMITTEE WITH FULL DELEGATION TO DETERMINE MATTERS ON THE AGENDA.

1 Apologies

2 Minutes

CONFIRMATION OF THE MINUTES OF THE ADMINISTRATION & FINANCE COMMITTEE MEETING HELD ON TUESDAY, 4TH DECEMBER, 2001.

3 Addresses to Committee by the Public

4 Mayoral Minutes

4.1 MAYOR'S MINUTE 2/2002 - REQUEST FOR PROVISION OF MARQUEE AT LA PEROUSE FOR THE ANNUAL PERE RECEVEUR MASS MONUMENT. 2

5 Finance

5.1 DIRECTOR GOVERNANCE MANAGEMENT & INFORMATION SERVICES' REPORT 1/2002 - INVESTMENT OF COUNCIL FUNDS AS AT 30 NOVEMBER 2001. 5

5.2 DIRECTOR GOVERNANCE MANAGEMENT & INFORMATION SERVICES' REPORT 2/2002 - INVESTMENT OF COUNCIL FUNDS AS AT 31 DECEMBER 2001. 14

6 General Business

7 Notice of Rescission Motions

.....
GENERAL MANAGER

MAYOR'S MINUTE 2/2002

SUBJECT:	REQUEST FOR PROVISION OF MARQUEE AT LA PEROUSE FOR THE ANNUAL PERE RECEVEUR MASS MONUMENT.
-----------------	--

DATE:	18 January, 2002	FILE NO:	98/S/0492
--------------	------------------	-----------------	-----------

REPORT BY: MAYOR

INTRODUCTION:

I have received advice from the organisers of the Annual Pere Receveur Historic Mass, that the annual mass is to be held at La Perouse on Sunday 17 February, 2002 at 11.00am and a cocktail party is planned on the evening prior to the commemorative mass on Saturday, 16 February.

ISSUES:

Since 1988, the St. Andrews Parish and the Friends of the La Perouse Museum organise the Annual Commemorative Mass for the late Pere Receveur, who died at Botany Bay on 17 February 1788. He was a Franciscan Priest and a noted scientist with the La Perouse expedition. The La Perouse area is almost certainly where the first Mass was celebrated in Australia.

The organisers have asked Council to assist with the costs associated with the hiring of a marquee for the Annual Pere Receveur Mass and with the costing associated with a cocktail party to be held on the prior evening.

It has been customary for the Randwick Council to host the La Perouse Day morning tea at the La Perouse museum and also for the Council to bear the costs of erecting a marquee so as the parishioners who attend the mass can be covered. The matter has been discussed with the French Consul-General, M. Finaud, and it has been agreed to hold the La Perouse Day celebrations (ordinarily celebrated on February 23rd each year) in conjunction with the Annual Mass to be held on Sunday 16th February.

The Friend's of La Perouse Museum have suggested that the costs of La Perouse Day be used to cover the Cocktail Party.

The Mass' finances have had to cover costs for the sound system, advertising, seating, and sundry expenses.

CONCLUSION:

RECOMMENDATION:

That Council agree to assist with the sponsorship of the Annual Pere Receveur Historic Mass, to be held on Sunday, 16 February 2002, by underwriting the hire charges of the marquee and cocktail party on Saturday 16 February 2002.

ATTACHMENT/S:

Letter from La Perouse Museum

.....
DOMINIC SULLIVAN
MAYOR

01-FEB-2002 12:49 FROM PREMIERS DEPARTMENT

TO 093999:116

F.01/01

FRIENDS OF THE LAPEROUSE MUSEUM INC.

V2639621

LAPEROUSE MUSEUM, ANZAC PARADE, LA PEROUSE, NSW 2036
PH/FAX (02) 9661 5182

1 February 2002

Dominic Sullivan
Mayor of Randwick Council
30 Francis St
Randwick
2031

Dear Dominic

I am writing to advise you of this year's plan for the celebrations of La Perouse Day and the annual mass in honour of Father Pere Laurent Receveur.

Considering that La Perouse Day is usually celebrated on 23 February and the annual mass is always held on the 2nd Sunday in February. We have decided this year to combine the two by having a cocktail party on Saturday 16 February and the mass on Sunday 17 February.

It has been customary for Randwick Council to host the La Perouse Day morning tea in the Instrument room within the La Perouse museum and also for the Council to pay for the cost of erecting a marquee so as the parishioners who attend the mass can be covered. Therefore, in lieu of the council paying for the morning tea, I am writing to request that the council pay for the provisions at the cocktail party which essentially would be champagne and chicken sandwiches and to continue to pay for the marquee the following day.

Yours sincerely

Chris Bastic

TOTAL P.01

Director Governance Management & Information Services' Report 1/2002



SUBJECT:	INVESTMENT OF COUNCIL FUNDS AS AT 30 NOVEMBER 2001
-----------------	--

DATE:	18 January, 2002	FILE NO:	98/S/0745
--------------	------------------	-----------------	-----------

REPORT BY: DIRECTOR GOVERNANCE MANAGEMENT & INFORMATION SERVICES

INTRODUCTION:

To report on Council's current investments.

ISSUES:

Council is authorised by s625 of the Local Government Act to invest its surplus funds. Funds may only be invested in the form of investment notified by Order of the Minister dated 29 November 2000.

The Local Government Financial Management Regulations prescribe the records that must be maintained in relation to Council's investments. The regulations also require that the responsible accounting officer provide a written report to each ordinary meeting of the Council giving details of all moneys invested and a certificate as to whether or not the investments have been made in accordance with the Act, the regulations and Council's Investment Policy No: 3.02.07.

Council's investment policy is currently been updated to incorporate a number of changes. This new policy will be submitted to Council shortly for its consideration.

Details of all investments are shown on the attachment sheet titled "Details of cash investments and analysis of investment performance as at 30 November 2001" and in the attached graphs.

CONCLUSION:

All surplus cash has been invested as at 30 November 2001 in accordance with Policy No: 3.02.07 and the provisions of s625 of the Local Government Act have been complied with.

RECOMMENDATION:

That the report dated 18 January 2002 in relation to the investment of Council funds be noted.

ATTACHMENT/S:

1. Details of cash investments and analysis of investment performance as at 30 November 2001.
2. Graphs.

.....
MARK HUMMERSTON
DIRECTOR GOVERNANCE
MANAGEMENT & INFORMATION
SERVICES

.....
BRIAN GREGAN
MANAGER, FINANCIAL
SERVICES

**DETAILS OF CASH INVESTMENTS AND ANALYSIS OF INVESTMENT PERFORMANCE
AS AT 30 NOVEMBER 2001**

Investment Manager	Credit Ratings	Amount Invested	Interest Earned November			UBSWA Bank Bill Index %	Interest Earned Financial Year to Date		UBSWA Bank Bill Index %	Interest Earned Last 12 Months		UBSWA Bank Bill Index %
			Amount	% Return			Amount	% Return		Amount	% Return	
	#	\$	\$	Month	Annualised	**	\$		**	\$		**
AMP Premium Treasury	AAf	8,104,791	23,979	0.30	3.54	0.36	142,972	4.92	4.96	353,201	5.43	5.42
ANZ Cash Plus	AAf	8,251,677	27,274	0.34	4.02	0.36	138,524	4.85	4.96	434,058	5.61	5.42
National Mutual Cash Enhanced	AAAm	7,938,484	22,962	0.39	4.62	0.36	137,592	4.65	4.96	366,229	5.62	5.42
CBA Premium Cash Enhanced	Aaf	4,623,826	16,514	0.36	4.26	0.36	40,340	5.37	4.96	40,340	-	5.42
LG Financial Services 11am Call	AA	5,201,654	4,918	0.37	4.40	0.36	56,557	4.40	4.96	124,260	-	5.42
Deutsche Cash Plus	BBB-AAA	5,719,721	12,995	0.37	4.44	0.36	70,076	5.08	4.96	88,173	5.81	5.42
UBS Credit Cash Enhanced	BBB-AAA	3,588,174	22,937	0.40	4.74	0.36	92,844	5.11	4.96	119,722	5.77	5.42
		43,428,327	131,579				678,905			1,525,983		

# Credit Ratings	Standard & Poors
Extremely strong capacity to pay	AAA
Very strong capacity to pay	AA
Adequate capacity to pay	BBB
Funds valued on a mark to market basis	f
Funds valued on an accruals basis	m

**UBSWA Bank Bill Index
-Is a performance benchmark published in the Australian Financial Review.
-The index rate can be compared to the interest rate earned by Council on its investments.

Interest Earned	\$
In November 2001	131,579
For 2001/2002 to 30 November –	686,418
Current estimate budget for interest earned – 2001/2002	1,500,000

Monthly earning rates for the last three months	Sept	Oct	Nov
	%	%	%
AMP Premium Treasury	0.40	0.38	0.30
ANZ Cash Plus	0.41	0.36	0.34
National Mutual Cash Enhanced	0.39	0.40	0.39
CBA Premium Cash Enhanced	0.42	0.37	0.36
LG Financial Services 11am Call	0.39	0.37	0.37
Deutsche Cash Plus	0.35	0.37	0.37
UBS Credit Cash Enhanced.	0.36	0.23	0.40
WDR Bank Bill Index	0.43	0.38	0.36

* Includes bank account interest as well as interest on investments with Managed Funds.

** Includes bank account interest and those Managed Funds no longer used.

I certify that the above investments have made in accordance with the Local Government Act, the regulations and Council’s investment policy No. 3.02.07.

BRIAN GREGAN
MANAGER, FINANCIAL SERVICES DIVISION

G:\COUNCIL\COMMITTEE\Finserv\Investment report 30.11.01.doc

ALL FUND MANAGER PERFORMANCE VS. UBSWA BANK BILL INDEX AS AT 31 NOVEMBER 2001

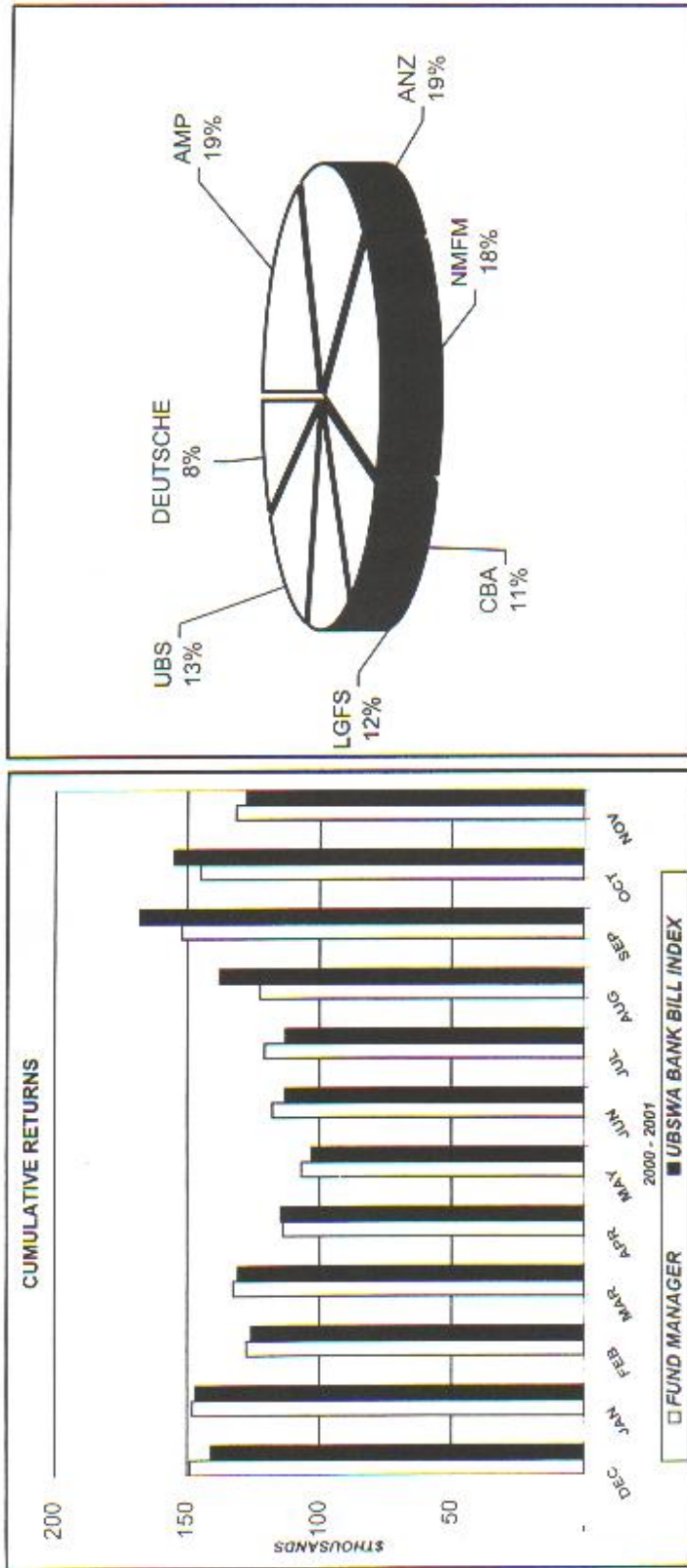

17/01/2002

g:\council\committee\fin\serv\12-2-02a.xls

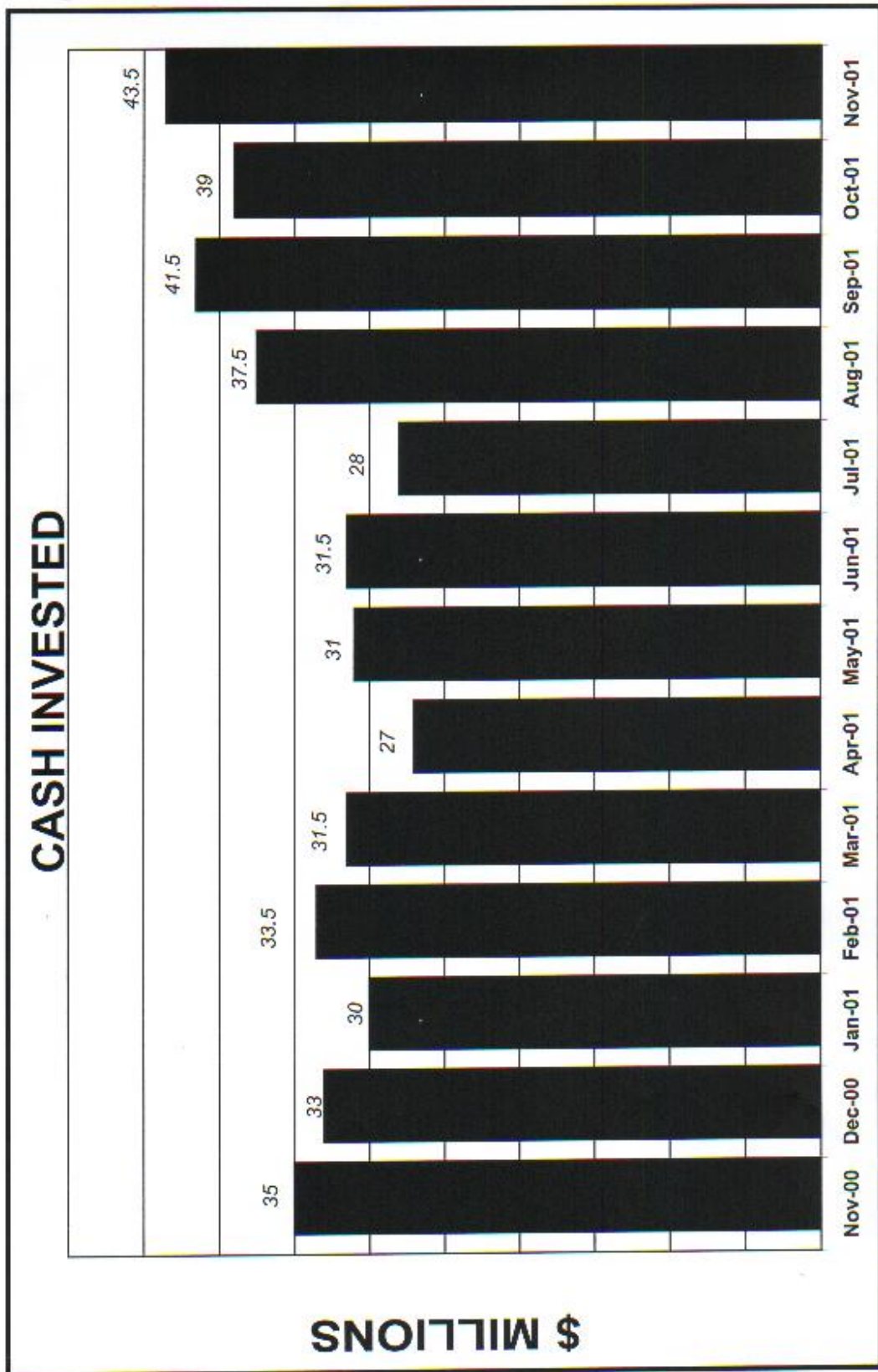

17/01/2002

g:\council\committee\finserve\12.2-02a.xls

**CASH INVESTMENTS BY FUND MANAGER
DECEMBER 00 - NOVEMBER 01**

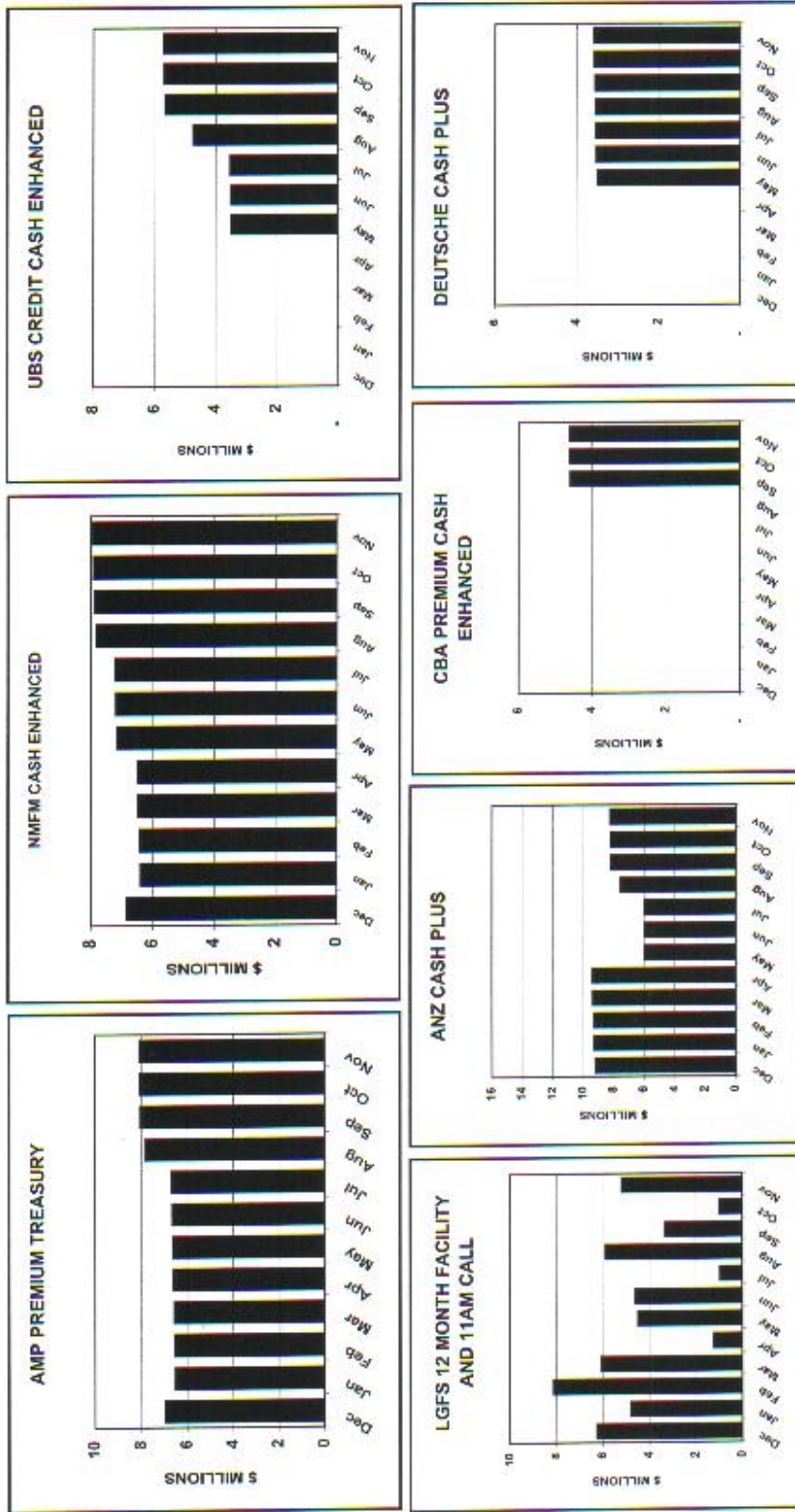

17/01/2002

g:\source\loc\min\tbl\fraser\12-02a.xls

**PERCENTAGE RETURN BY FUND MANAGER
DECEMBER 00 - NOVEMBER 01**

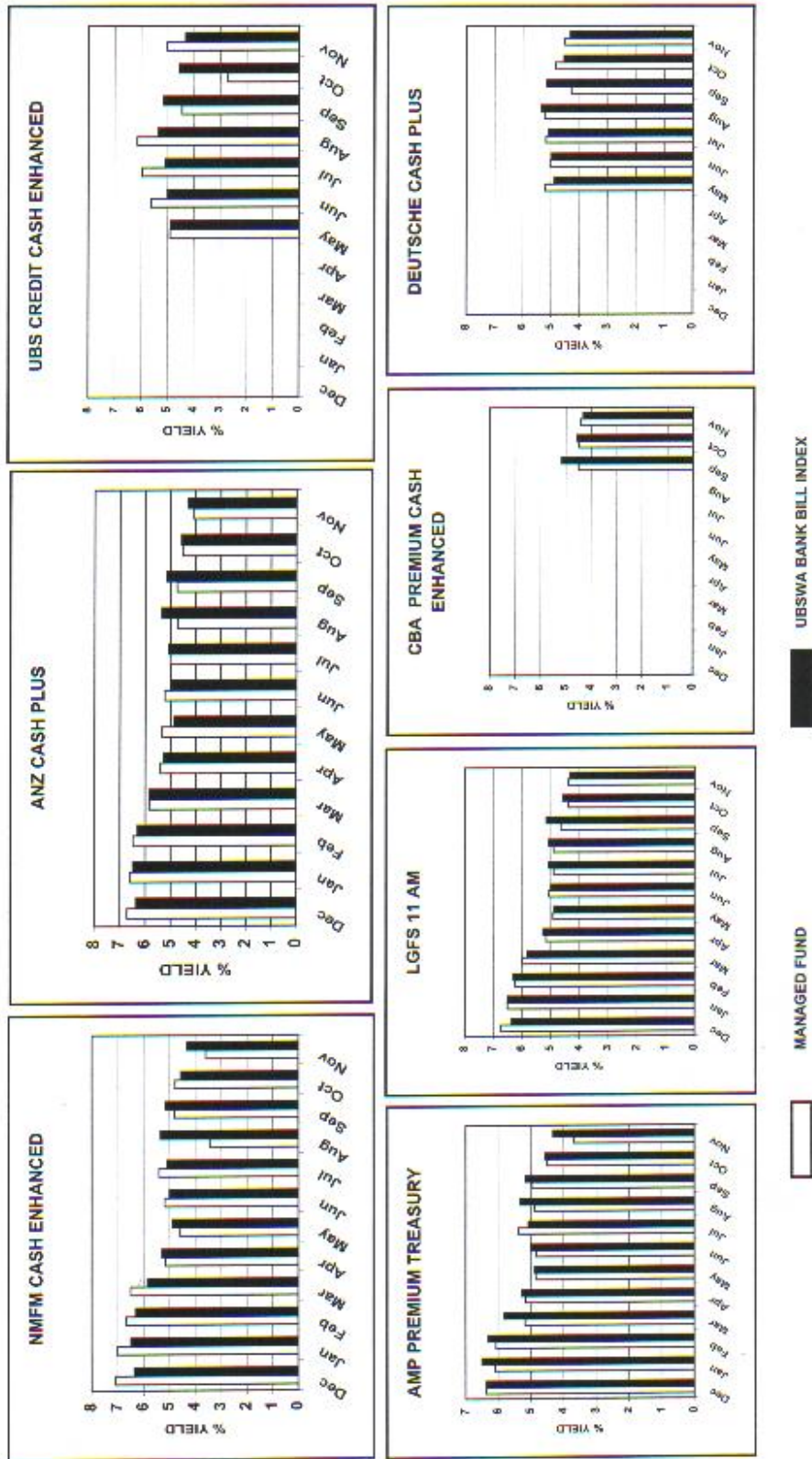

Q:\admin\fac\minutef\www\12-2-02\fa.doc 17/01/2002

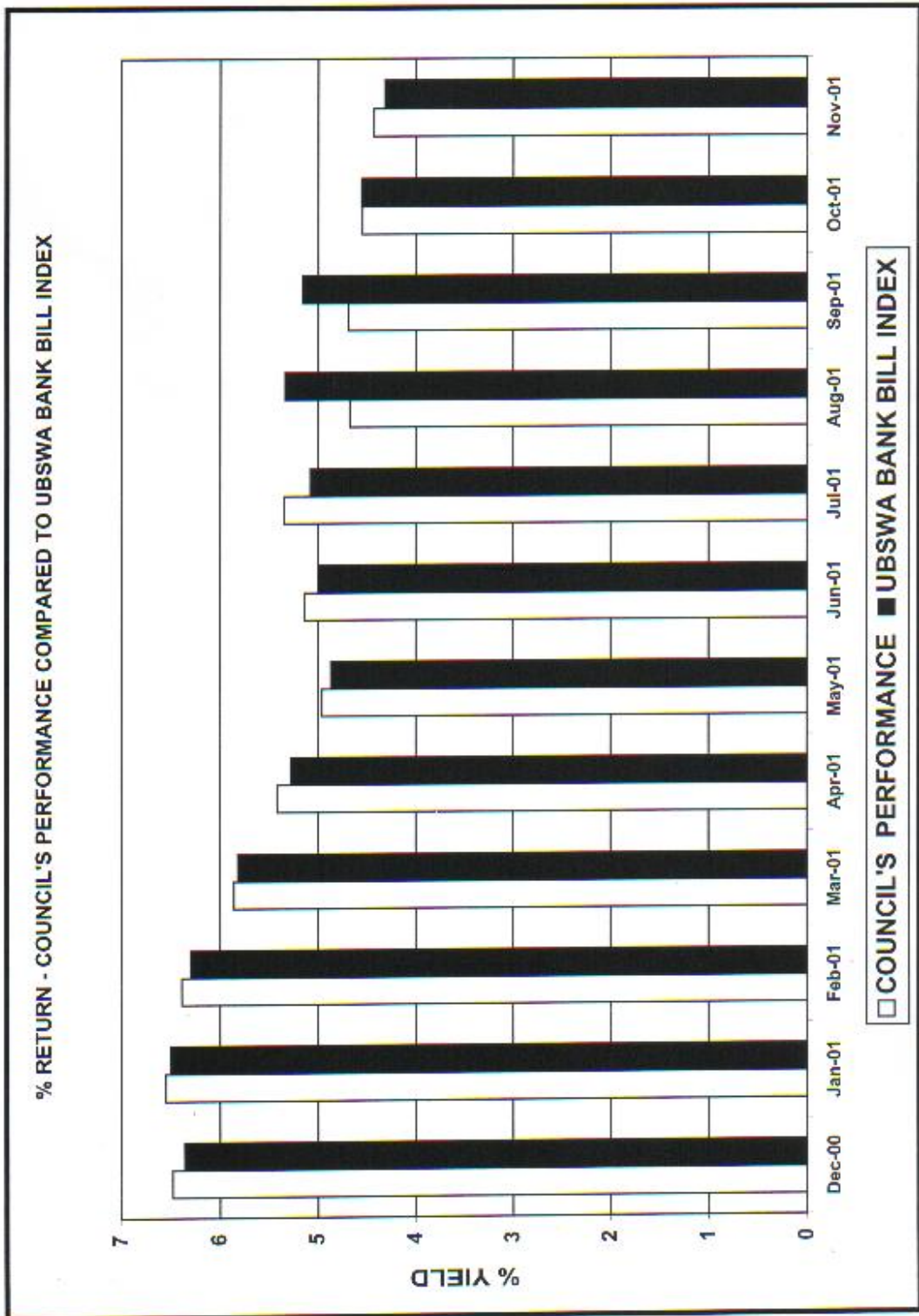

17/01/2002

g:\council\committee\finserve\12-2-02a.xls



Director Governance Management & Information Services' Report 2/2002

SUBJECT:	INVESTMENT OF COUNCIL FUNDS AS AT 31 DECEMBER 2001
-----------------	--

DATE:	29 January, 2002	FILE NO:	98/S/0745
--------------	------------------	-----------------	-----------

REPORT BY: DIRECTOR GOVERNANCE MANAGEMENT & INFORMATION SERVICES

INTRODUCTION:

To report on Council's current investments.

ISSUES:

Council is authorised by s625 of the Local Government Act to invest its surplus funds. Funds may only be invested in the form of investment notified by Order of the Minister dated 29 November 2000.

The Local Government Financial Management Regulations prescribe the records that must be maintained in relation to Council's investments. The regulations also require that the responsible accounting officer provide a written report to each ordinary meeting of the Council giving details of all moneys invested and a certificate as to whether or not the investments have been made in accordance with the Act, the regulations and Council's Investment Policy No: 3.02.07.

Council's investment policy is currently been updated to incorporate a number of changes. This new policy will be submitted to Council shortly for its consideration.

Details of all investments are shown on the attachment sheet titled "Details of cash investments and analysis of investment performance as at 31 December 2001" and in the attached graphs.

CONCLUSION:

All surplus cash has been invested as at 31 December 2001 in accordance with Policy No: 3.02.07 and the provisions of s625 of the Local Government Act have been complied with.

RECOMMENDATION:

That the report dated 18 January 2002 in relation to the investment of Council funds be noted.

ATTACHMENT/S:

1. Details of cash investments and analysis of investment performance as at 31 December, 2001.
2. Graphs

.....
MARK HUMMERSTON
DIRECTOR GOVERNANCE
MANAGEMENT & INFORMATION
SERVICES

.....
BRIAN GREGAN
MANAGER, FINANCIAL
SERVICES

**DETAILS OF CASH INVESTMENTS AND ANALYSIS OF INVESTMENT PERFORMANCE
AS AT 31 DECEMBER 2001**

Investment Manager	Credit Ratings	Amount Invested	Interest Earned December			UBSWA Bank Bill Index %	Interest Earned Financial Year to Date		UBSWA Bank Bill Index %	Interest Earned Last 12 Months		UBSWA Bank Bill Index %
			Amount	% Return			Amount	% Return		Amount	% Return	
				\$	Month							
AMP Premium Treasury	AAf	8,134,571	29,780	0.37	4.38	0.36	172,753	4.88	4.86	346,618	5.26	5.24
ANZ Cash Plus	AAf	8,279,631	27,954	0.35	4.14	0.36	166,478	4.77	4.86	410,072	5.39	5.24
National Mutual Cash Enhanced	AAAm	7,970,632	32,148	0.41	4.86	0.36	169,740	4.74	4.86	359,298	5.42	5.24
CBA Premium Cash Enhanced	Aaf	5,640,340	18,495	0.34	4.02	0.36	58,835	5.17	4.86	58,835	5.59	5.24
LG Financial Services 11am Call	AA	3,356,573	17,268	0.35	4.15	0.36	73,825	4.15	4.86	124,782	-	5.24
Deutsche Cash Plus	BBB-AAA	3,601,891	13,717	0.39	4.68	0.36	83,793	5.05	4.86	101,890	5.64	5.24
UBS Credit Cash Enhanced	BBB-AAA	5,741,539	21,818	0.38	4.50	0.36	114,661	5.06	4.86	141,540	5.60	5.24
		42,725,176	161,180				840,085			1,543,035		

# Credit Ratings	Standard & Poors
Extremely strong capacity to pay	AAA
Very strong capacity to pay	AA
Adequate capacity to pay	BBB
Funds valued on a mark to market basis	f
Funds valued on an accruals basis	m

**UBSWA Bank Bill Index
-Is a performance benchmark published in the Australian Financial Review.
-The index rate can be compared to the interest rate earned by Council on its investments.

Interest Earned	
\$	
In December 2001	164,793
For 2001/2002 to 31 December –	851,211
Current estimate budget for interest earned – 2001/2002	1,504,000

Monthly earning rates for the last three months	Oct	Nov	Dec
	%	%	%
* AMP Premium Treasury	0.38	0.30	0.37
** ANZ Cash Plus	0.36	0.34	0.35
National Mutual Cash Enhanced	0.40	0.39	0.41
CBA Premium Cash Enhanced	0.37	0.36	0.34
LG Financial Services 11am Call	0.37	0.37	0.35
Deutsche Cash Plus	0.37	0.37	0.39
UBS Credit Cash Enhanced.	0.23	0.40	0.38
WDR Bank Bill Index	0.38	0.36	0.36

* Includes bank account interest as well as interest on investments with Managed Funds.

** Includes bank account interest and those Managed Funds no longer used.

I certify that the above investments have made in accordance with the Local Government Act, the regulations and Council's investment policy No. 3.02.07.

BRIAN GREGAN

MANAGER, FINANCIAL SERVICES DIVISION

G:\COUNCIL\COMMITTEE\Finserv\Investment report 31.12.01.doc

ALL FUND MANAGER PERFORMANCE VS. UBSWA BANK BILL INDEX AS AT 31 DECEMBER 2001

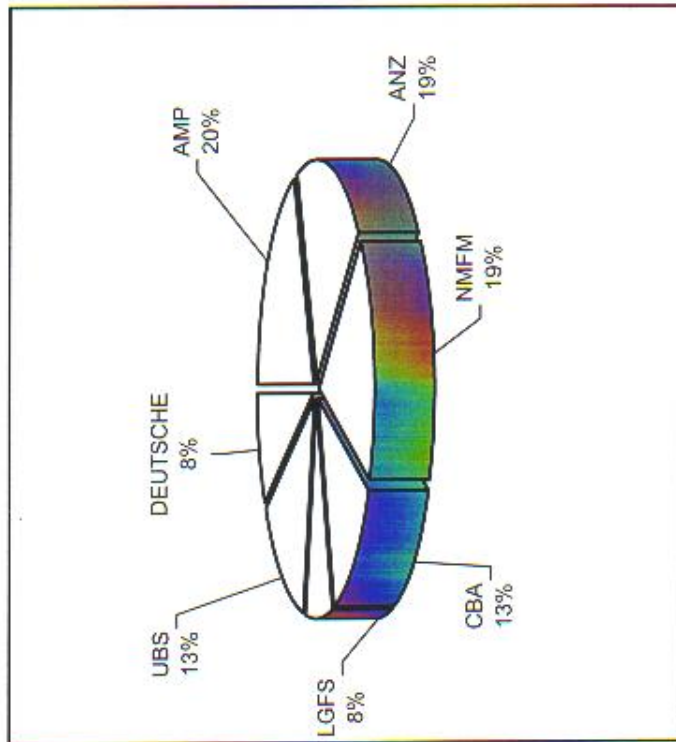
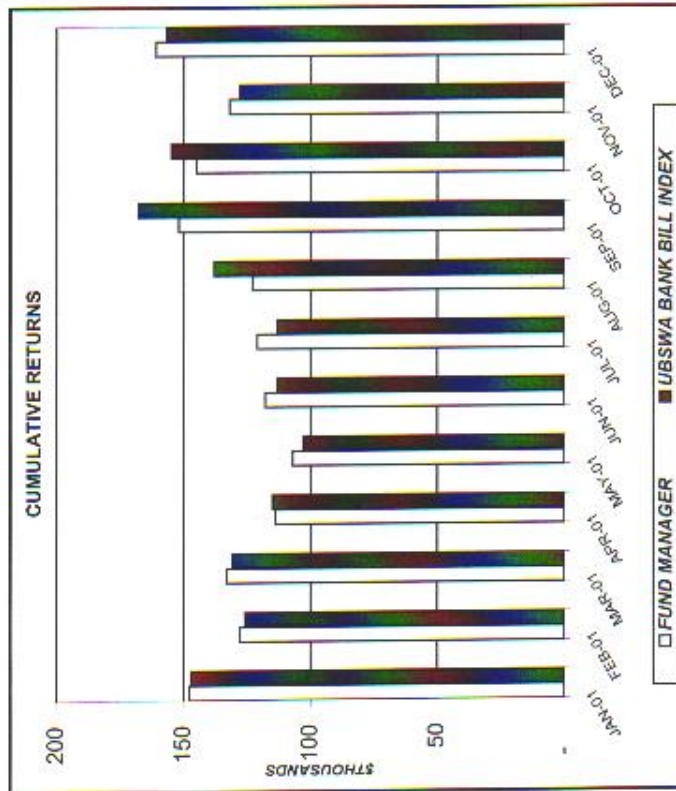

18/01/2002

g:\council\committee\finser\12-2-02a.xls

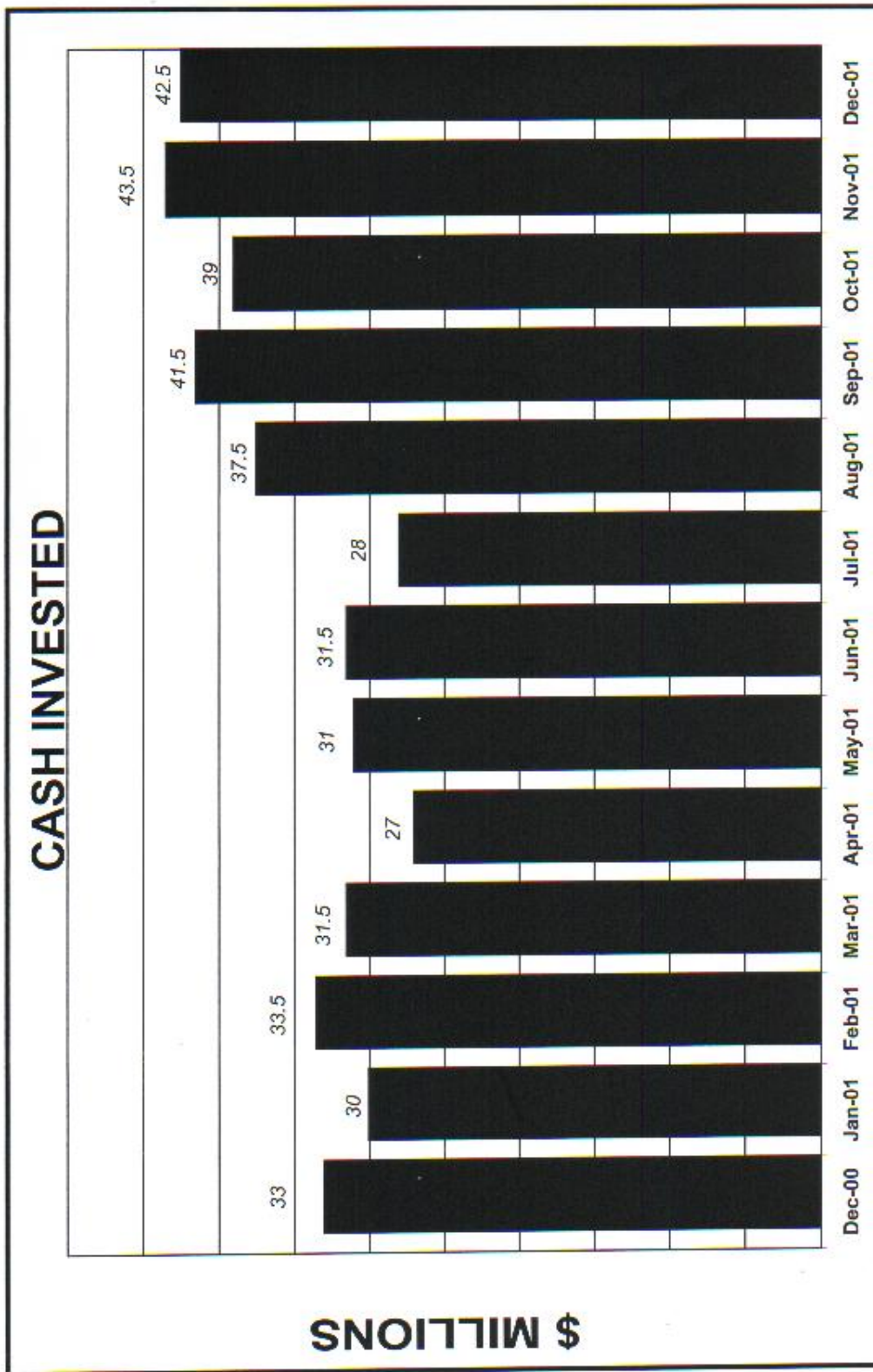

**CASH INVESTMENTS BY FUND MANAGER
JANUARY 01 - DECEMBER 01**

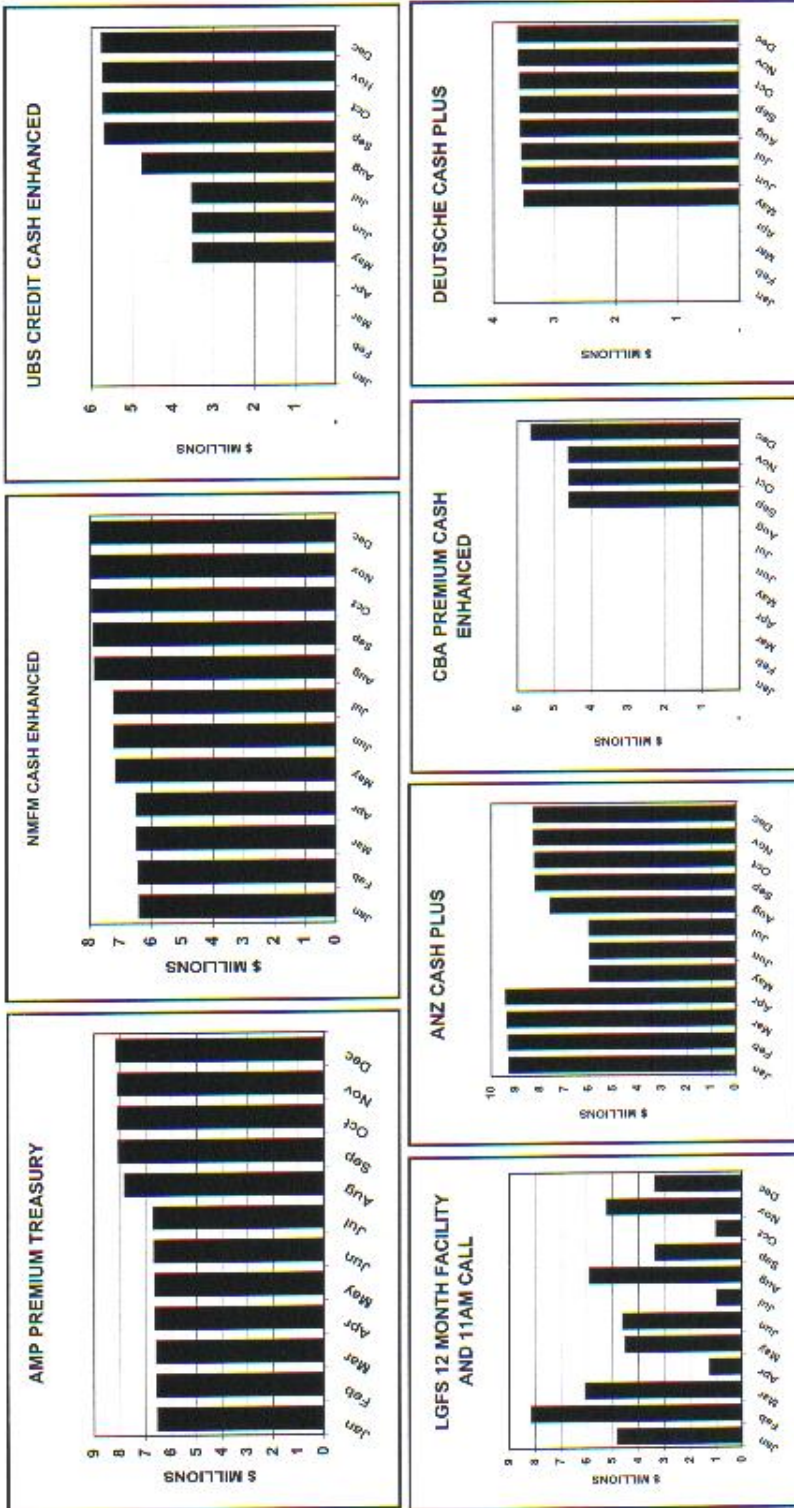

18/01/2002

s:\sound\committee\mnserv\12.2 02a.xls

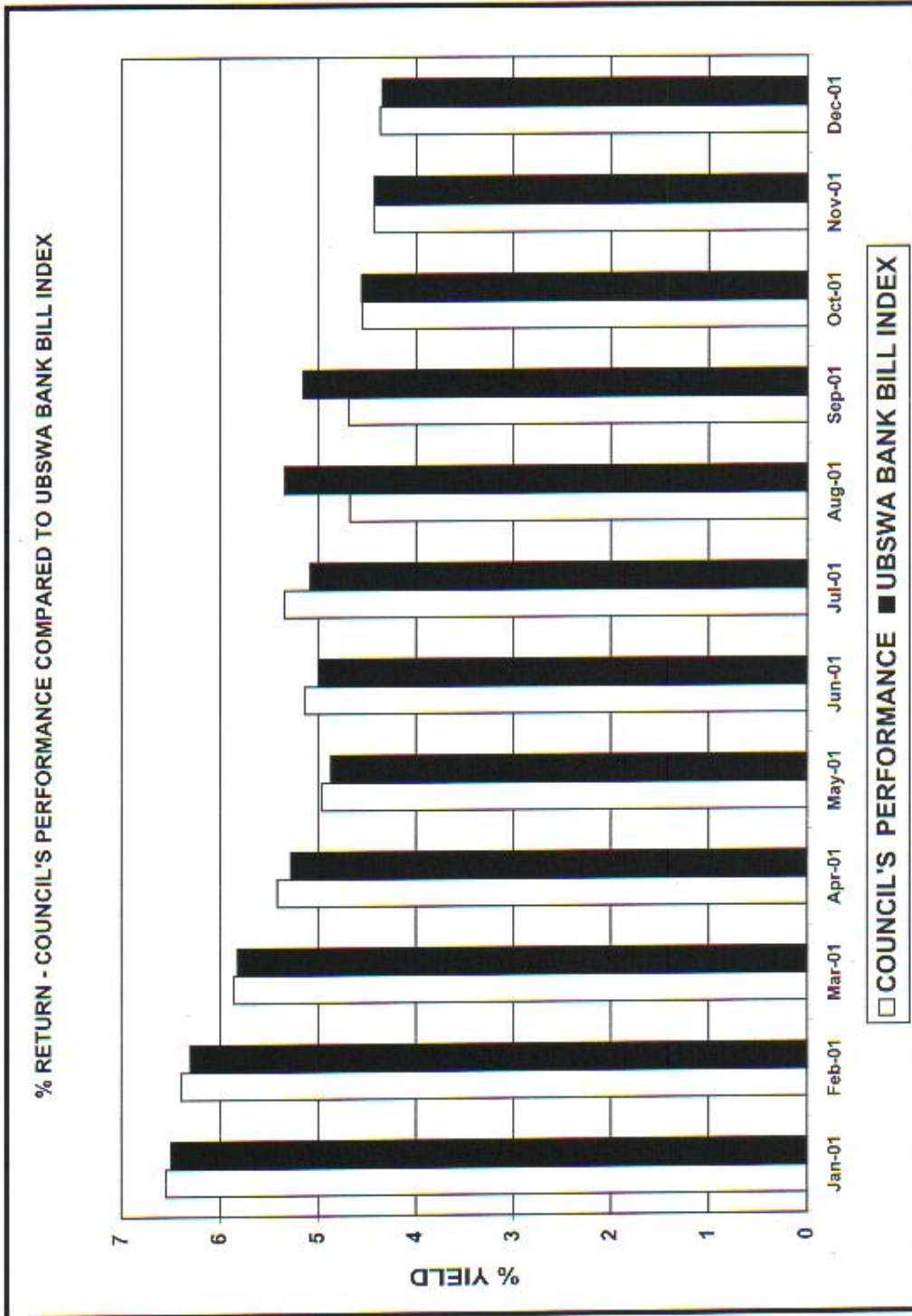

18/01/2002

g:\council\committee\finserve\12-2-02a.xls

